



ULN2003

LINEAR INTEGRATED CIRCUIT

7CH DARLINGTON SINK DRIVER

DESCRIPTION

The UTC **ULN2003** are high-voltage, high-current darlington drivers comprised of seven NPN Darlington pairs.

All units feature integral clamp diodes for switching inductive loads.

Applications include relay, hammer, lamp and display (LED) drivers.

FEATURES

*Output Current (Single Output): 500mA (MAX.)

*High Sustaining Voltage Output: 50V (MIN.)

*Output Clamp Diodes

*Inputs Compatible With Various Types Of Logic

ORDERING INFORMATION

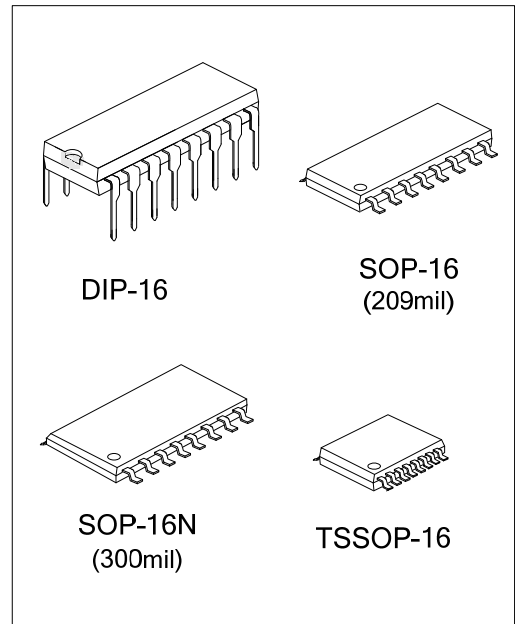

Ordering Number		Package	Packing
Lead Free	Halogen Free		
ULN2003L-D16-T	ULN2003G-D16-T	DIP-16	Tube
-	ULN2003G-S16-R	SOP-16	Tape Reel
ULN2003L-S16N-R	ULN2003G-S16N-R	SOP-16N	Tape Reel
-	ULN2003G-P16-R	TSSOP-16	Tape Reel

<p>ULN2003L-D16-T</p> <p>(1) Packing Type</p> <p>(2) Package Type</p> <p>(3) Green Package</p>	<p>(1) T: Tube, R: Tape Reel</p> <p>(2) D16: DIP-16, S16: SOP-16, S16N: SOP-16N P16: TSSOP-16</p> <p>(3) L: Lead Free, G: Halogen Free and Lead Free</p>
--	--

MARKING

Package	MARKING
DIP-16	
SOP-16 TSSOP-16	
SOP-16N	

PIN CONNECTION

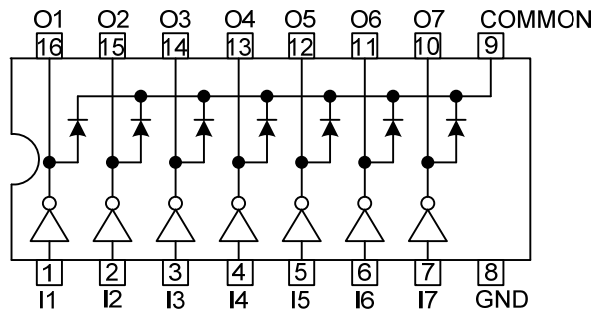

BLOCK DIAGRAM

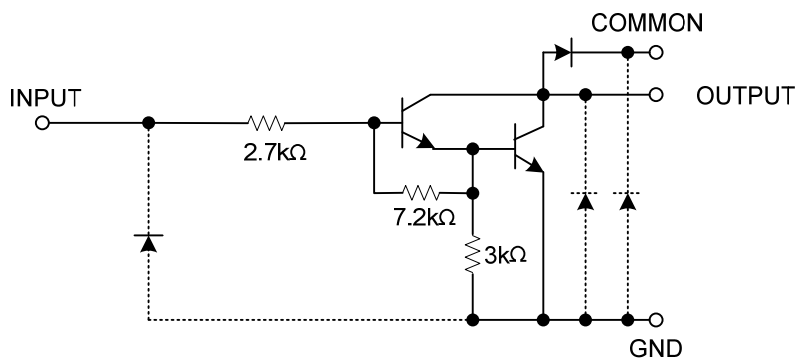

Note: The input and output parasitic diodes cannot be used as clamp diodes.

■ ABSOLUTE MAXIMUM RATINGS ($T_A=25^{\circ}\text{C}$, unless otherwise specified)

PARAMETER		SYMBOL	RATING	UNIT
Output Sustaining Voltage		V_{OUT}	-0.5~50	V
Input Voltage		V_{IN}	-0.5~30	V
Clamp Diode Reverse Voltage		V_R	50	V
Output Current		I_{OUT}	500	mA / ch
Clamp Diode Forward Current		I_F	500	mA
Power Dissipation	DIP-16	P_D	1.47	W
	SOP-16/SOP-16N		1.25 (Note2)	W
	TSSOP-16		0.62	W
Junction Temperature		T_J	+125	$^{\circ}\text{C}$
Operating Temperature		T_{OPR}	-40~+85	$^{\circ}\text{C}$
Storage Temperature		T_{STG}	-55~+150	$^{\circ}\text{C}$

Note: 1. Absolute maximum ratings are those values beyond which the device could be permanently damaged.

Absolute maximum ratings are stress ratings only and functional device operation is not implied.

2. On PCB (Test Board: JEDEC 2s2p)

■ RECOMMENDED OPERATING CONDITIONS ($T_A=-40\sim+85^{\circ}\text{C}$, unless otherwise specified)

CHARACTERISTIC		SYMBOL	TEST CONDITIONS	MIN	TYP	MAX	UNIT
Output Sustaining Voltage		V_{OUT}		0		50	V
Output Current	DIP-16	I_{OUT}	$T_{PW} = 25\text{ms}$ 7 Circuits $T_A = 85^{\circ}\text{C}$ $T_J = 120^{\circ}\text{C}$	Duty = 10%	0	350	mA/ch
				Duty = 50%	0	100	
	SOP-16 SOP-16N			Duty = 10%	0	300	
				Duty = 50%	0	90	
	TSSOP-16			Duty = 50%	0		
				Duty = 10%	0	150	
				Duty = 50%	0	30	
Input Voltage		V_{IN}		0		24	V
Input Voltage (Output On)		$V_{IN(ON)}$	$I_{OUT} = 400\text{mA}$	2.8		24	V
Input Voltage (Output Off)		$V_{IN(OFF)}$		0		0.7	V
Clamp Diode Reverse Voltage		V_R				50	V
Clamp Diode Forward Current		I_F				350	mA
Power Dissipation	DIP-16	P_D	$T_A = 85^{\circ}\text{C}$			0.76	W
	SOP-16 SOP-16N		$T_A = 85^{\circ}\text{C}$ (Note)			0.65	
	TSSOP-16		$T_A = 85^{\circ}\text{C}$			0.32	

Note: On PCB (Test Board: JEDEC 2s2p)

■ ELECTRICAL CHARACTERISTICS (T_A=25°C, unless otherwise specified)

CHARACTERISTIC	SYMBOL	TEST CIRCUIT	TEST CONDITIONS	MIN	TYP	MAX	UNIT
Output Leakage Current	I _{LEAK}	1	V _{CE} = 50 V, T _A = 25°C			50	μA
			V _{CE} = 50 V, T _A = 85°C			100	
Collector-Emitter Saturation Voltage	V _{CEO(SAT)}	2	I _{OUT} = 350 mA, I _{IN} = 500 μA		1.3	1.6	V
			I _{OUT} = 200 mA, I _{IN} = 350 μA		1.1	1.3	
			I _{OUT} = 100 mA, I _{IN} = 250 μA		0.9	1.1	
DC Current Transfer Ratio	h _{FE}	2	V _{CE} = 2 V, I _{OUT} = 350 mA	1000			
Input Current (Output On)	I _{IN(ON)}	3	V _{IN} = 2.4 V, I _{OUT} = 350 mA		0.4	0.7	mA
Input Current (Output Off)	I _{IN(OFF)}	4	I _{OUT} = 500 μA, T _A = 85°C	50	65		μA
Input Voltage (Output On)	V _{IN(ON)}	5	V _{CE} = 2 V	I _{OUT} = 350 mA		2.6	V
				I _{OUT} = 200 mA		2.0	
Clamp Diode Reverse Current	I _R	6	V _R = 50 V, T _A = 25°C			50	μA
			V _R = 50 V, T _A = 85°C			100	
Clamp Diode Forward Voltage	V _F	7	I _F = 350 mA			2.0	V
Input Capacitance	C _{IN}				15		pF
Turn-On Delay	t _{ON}	8	V _{OUT} = 50 V, R _L = 125 Ω C _L = 15 pF		0.1		μs
Turn-Off Delay	t _{OFF}	8	V _{OUT} = 50 V, R _L = 125 Ω C _L = 15 pF		0.2		

■ TEST CIRCUIT

Components in the test circuits are used only to obtain and confirm the device characteristics. These components and circuits are not guaranteed to prevent malfunction or failure from occurring in the application equipment.

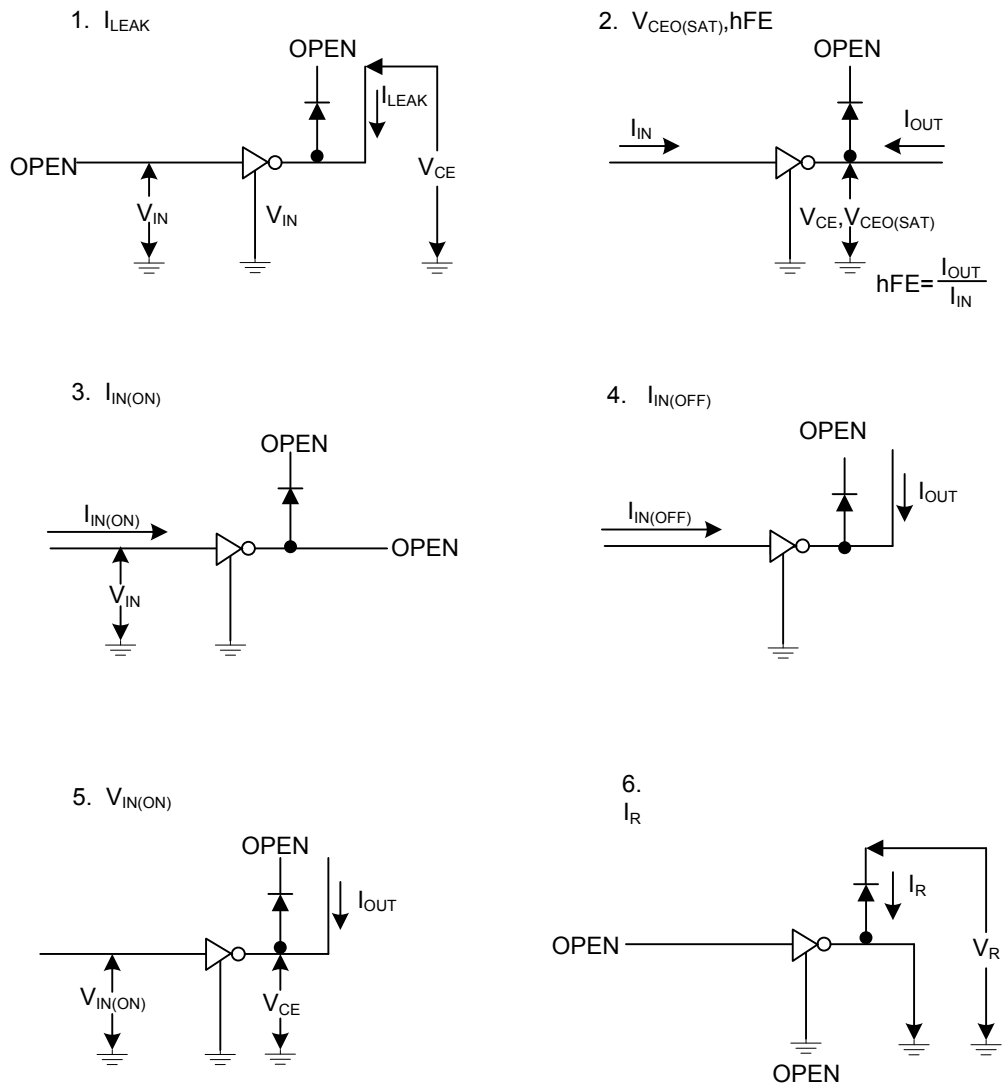

■ TEST CIRCUIT(Cont.)

7. V_F

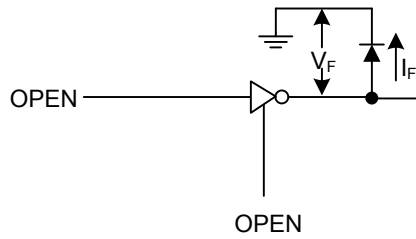

8. t_{ON}, t_{OFF}

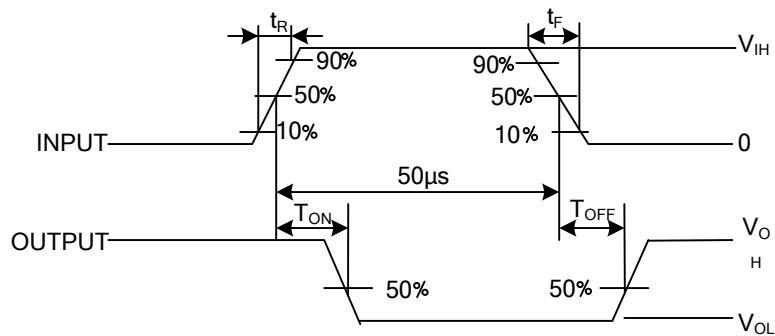
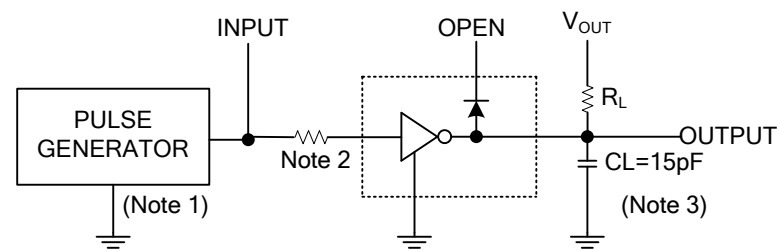

Note 1: Pulse width 50µs ,duty cycle 10%
Output impedance 50Ω $t_r \leq 5ns$, $t_f \leq 10ns$

Note 2: See below

INPUT CONDITION

TYPE NUMBER	R1	V_{IH}
ULN2003	0	3V

Note 3: C_L includes probe and jig capacitance

■ APPLICATION NOTES

This UTC **ULN2003** has no protection functions for over-current and over-voltage. If the applied situation includes over-current or over-voltage, this IC may be destroyed. We should take care of the systems design with this IC. The OUTPUT, COMMON and GND lines should be designed carefully, because the IC may be destroyed due to short-circuit between outputs, air contamination fault, or fault by improper grounding.

The UTC **ULN2003** is a darlington driver array. When it is applied with a general logic circuit such as TTL or CMOS, resistors should be connected in series to every input to achieve a stable input current.

When the load is connected between the output and the power supply, the COMMON pin should be shorted to the power supply to protect the IC from extra swing voltage.

■ NOTICE ON PRODUCT USE

(1) The absolute maximum ratings should be not exceeded, even for a moment, otherwise the device may be breakdown, damaged or deteriorated, and even injury by explosion or combustion.

(2) The power supply fuse should be used to prevent a continuous large current from the over current situation and IC failure. The improper wiring layout and an abnormal pulse noise from the wiring or load both can cause a large continuous current and even the breakdown, and finally can lead smoke or ignition. So we should design carefully considering fuse capacity, fusing time and insertion circuit location, the effects of a large current can be improved.

(3) When the inductive load is applied such as motor coil, it can cause the device malfunction or breakdown due to the current resulting from the inrush current at power ON or the negative current resulting from the back electromotive force at power OFF, so a protection circuit should be designed. When using build-in protection functions IC, a stable power supply is required, otherwise the protection function may not operate and cause IC breakdown. IC breakdown may result injury, smoke or ignition.

(4) The devices should not be mounted in the wrong orientation or incorrectly, and the positive and negative terminals of power supplies should also be connected properly, otherwise the current or power consumption may exceed the absolute maximum rating, also it may cause the device breakdown, damage or deterioration, and may result injury by explosion or combustion. In addition, any device should not be used when it is applied the current with mounted in the wrong orientation or incorrectly even just one time.

(5) The careful selection of external components is also important, such as inputs and negative feedback capacitors, load components (such as speakers), power amp and regulator. If a large leakage current flow the input or negative feedback capacitors, the IC output DC voltage will be increased. If this output voltage is connected to a speaker with low input withstand voltage, the smoke or ignition can be caused for over-current or IC failure, even the smoke or ignition from the IC itself. In addition, please also pay attention to the Bridge Tied Load (BTL) connection type IC that inputs output DC voltage to a speaker directly.

■ POINTS TO REMEMBER ON PRODUCT USE

(1) Heat Dissipation Design

An inadequate IC heat dissipation design can reduce the IC life, deterioration of IC characteristics, even IC breakdown. When the IC is applied with a large current flow such as power amp, regulator and so on, the careful heat dissipation design should be implemented, not to exceed the maximum ratings of junction temperature (Tj). Meanwhile, also please pay attention to the effect of IC heat dissipation on peripheral components.

(2) Back-EMF

Being the effect of back-EMF, a current can flow back to the motor's power supply when a motor rotates in the reverse direction, stops or slows down suddenly. If the power supply has a low current sink capability, the device's motor power supply and output pins might be influenced for exceeding the absolute maximum ratings. In the system design, we should take the effect of back-EMF into consideration to avoid the accident.

TYPICAL CHARACTERISTICS

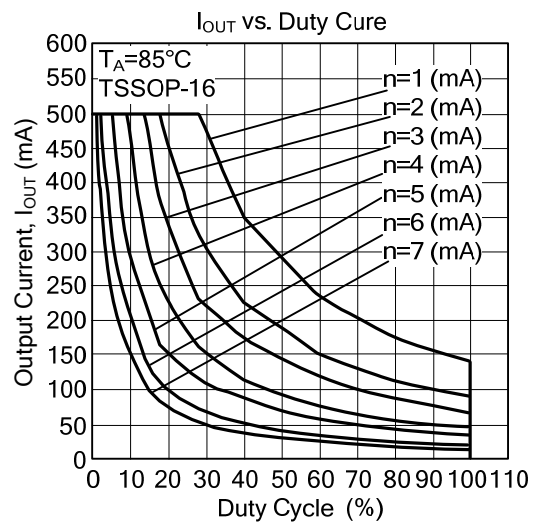
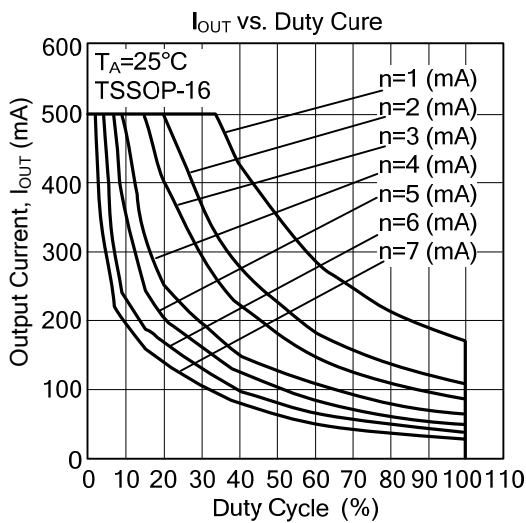
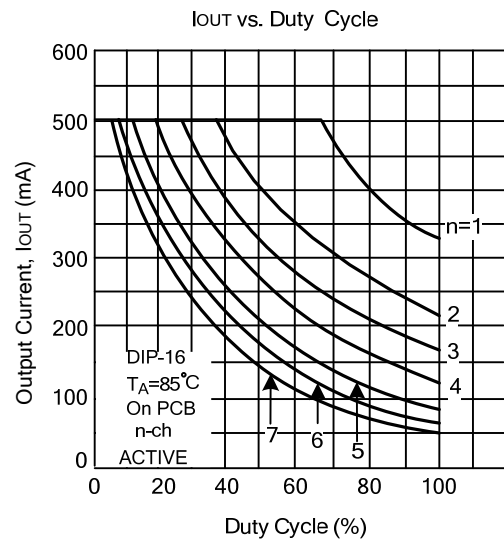
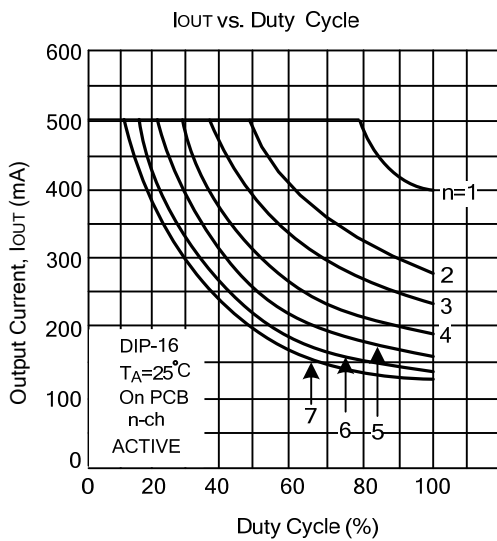
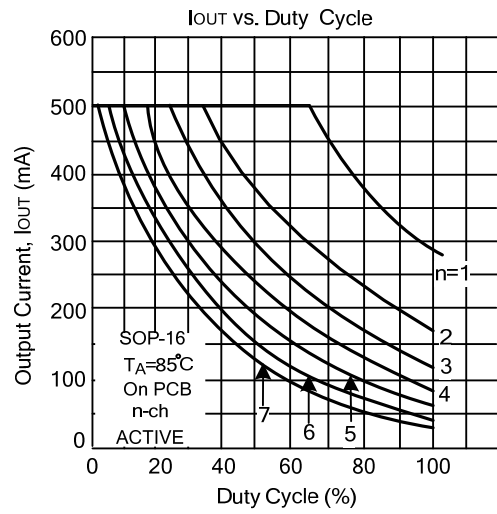
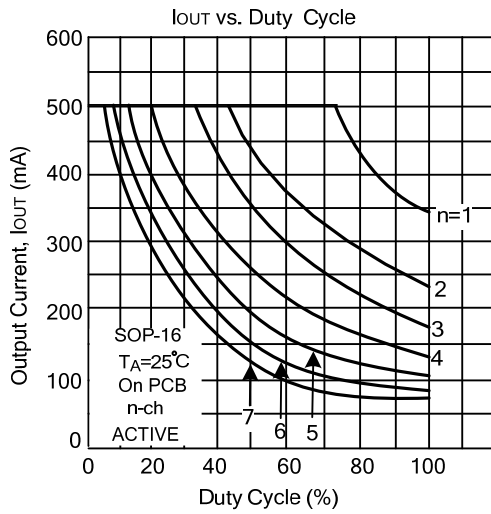

TYPICAL CHARACTERISTICS(Cont.)

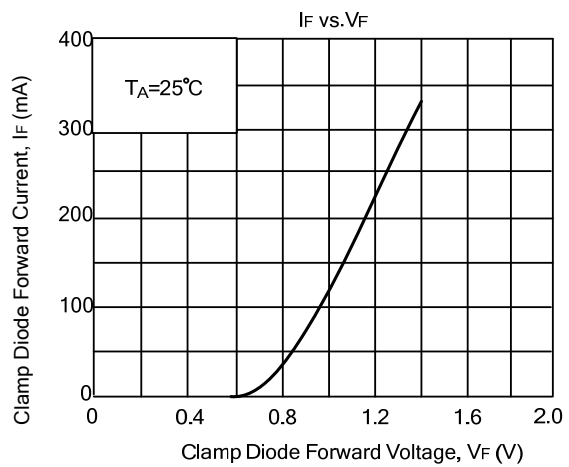
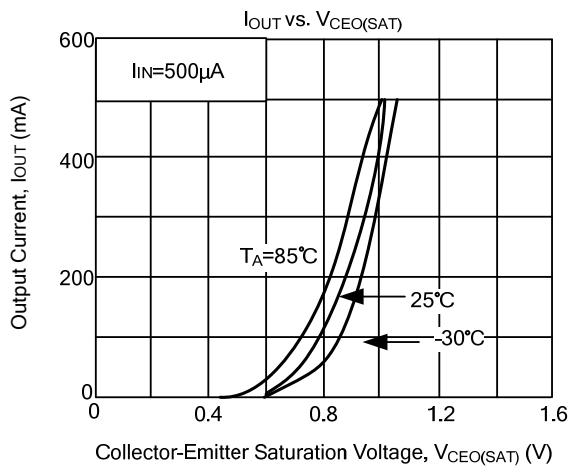
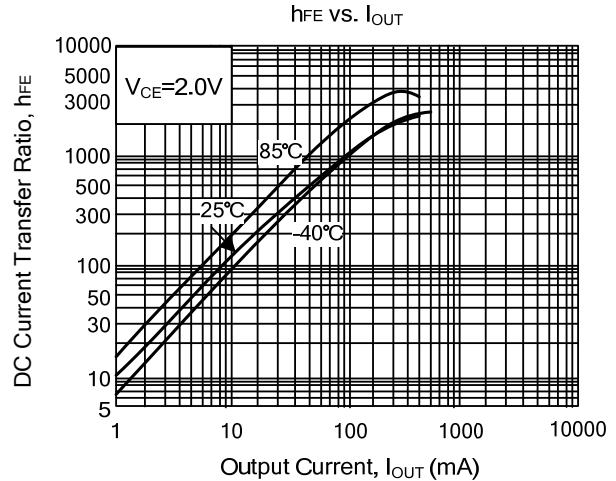
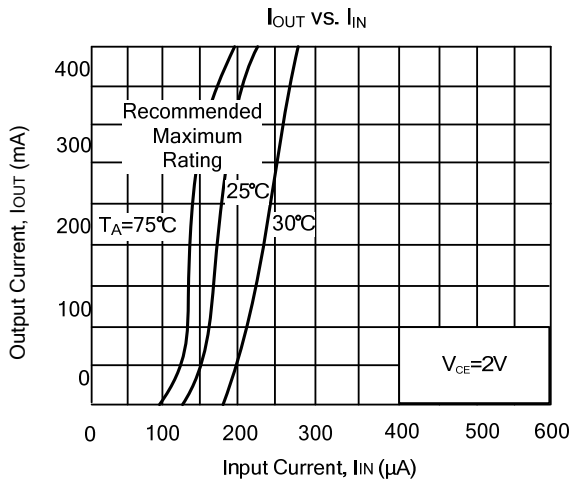
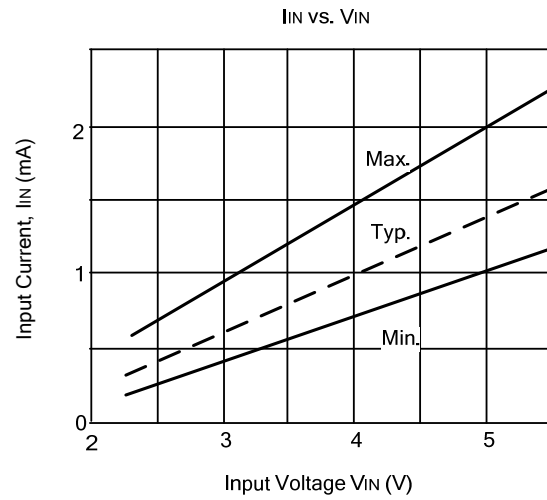
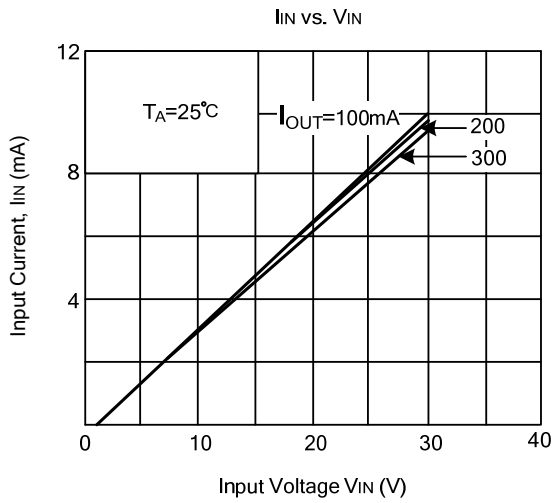

■ TYPICAL CHARACTERISTICS(Cont.)

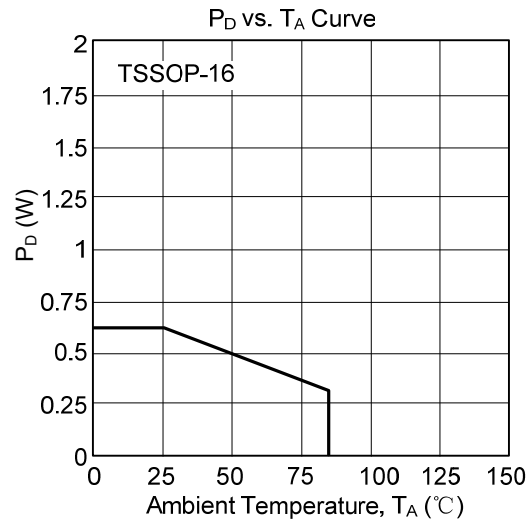
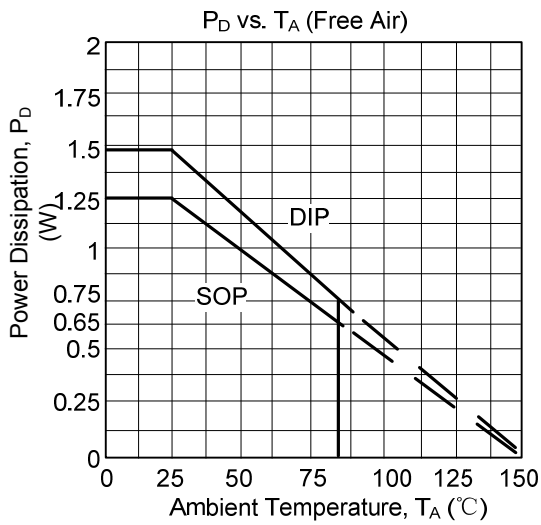

UTC assumes no responsibility for equipment failures that result from using products at values that exceed, even momentarily, rated values (such as maximum ratings, operating condition ranges, or other parameters) listed in products specifications of any and all UTC products described or contained herein. UTC products are not designed for use in life support appliances, devices or systems where malfunction of these products can be reasonably expected to result in personal injury. Reproduction in whole or in part is prohibited without the prior written consent of the copyright owner. The information presented in this document does not form part of any quotation or contract, is believed to be accurate and reliable and may be changed without notice.